



neolab Migge GmbH
Rischerstr. 7-9
69123 Heidelberg
Deutschland
+49 (0)6221 /
8442-44
<https://www.neolab.de>
e

Umsatzsteuer-
Identifikationsnummer
:
DE 143 450 657



neolab® laboratory lifting platform 200 x 200 mm, powder-coated light metal

Special Price
€122.00 was
€147.00
plus VAT &
Shipping

Product Images

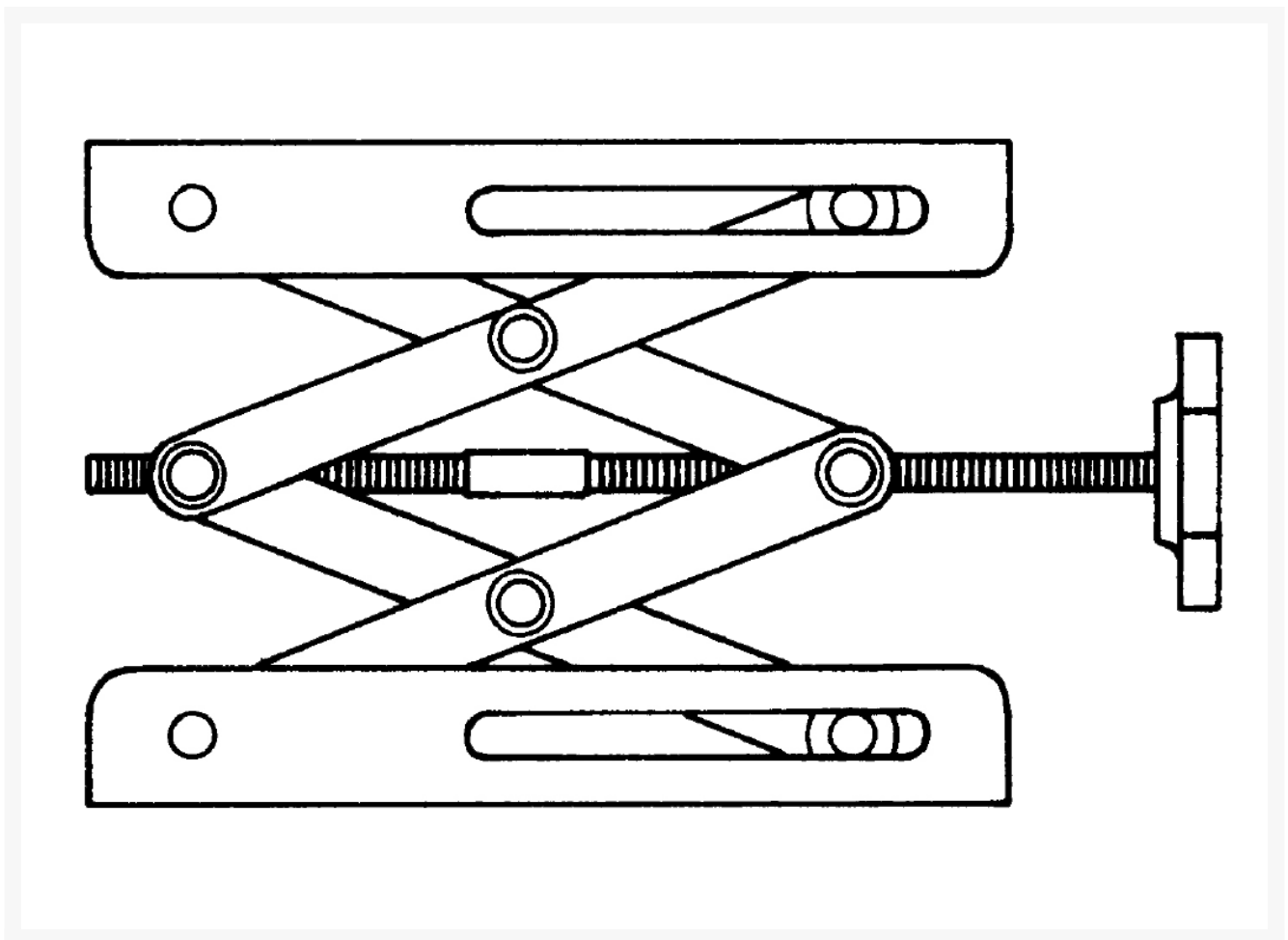

Description

Laboratory lifting platform made of light metal with powder coating, in starting position loadable up to 60 kg, max. operating load according to DIN 12897.

Additional Information

No.	E-1708
Manufacturer (Brand)	neoLab
EAN	4058072066666
Transport temperature	Room temperature
Material	Aluminum powder coated
Wide	200 mm
Length	200 mm
Height [MAX]	260 mm
Height [MIN]	70 mm
loadable up to	7 kg

